

# Data Sheet



Article number: 03705025

Description: Fluro rod end BRM 25 L  
threaded left with ball bearing

## Measures

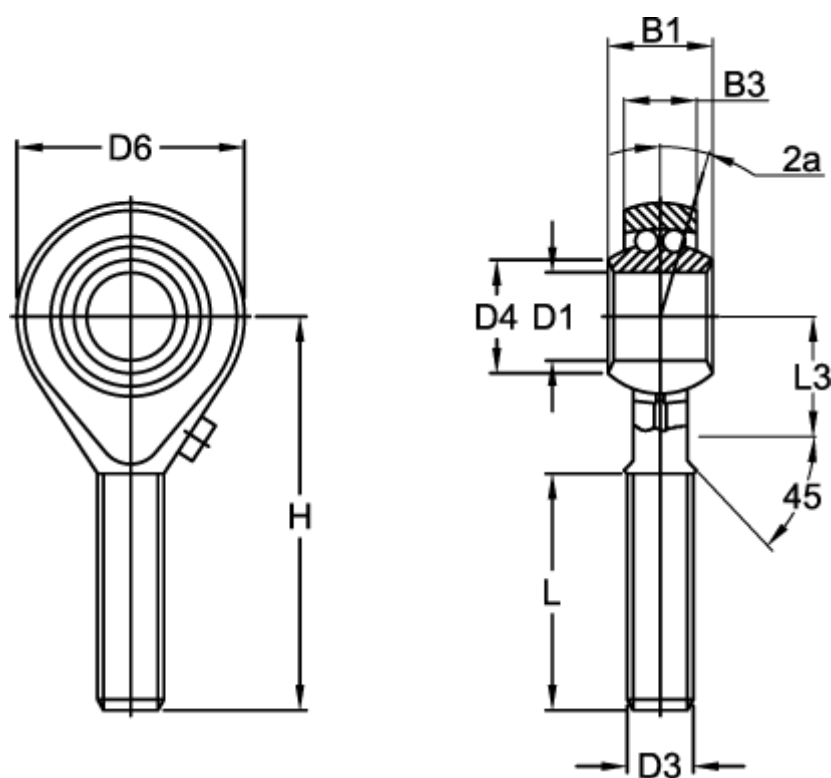

Angel 2a	= 5.0	H	= 94
B1	= 31	L	= 57
B3	= 22.00	L3	= 30
D1	= 25	Max rpm	= 600
D3	= M24x2	Static load (N)	= 5680
D4	= 29.5	Weight (kg)	= 0.602
D6	= 64		
Dynamic load C (N)	= 11030.0		